

Suction capacity

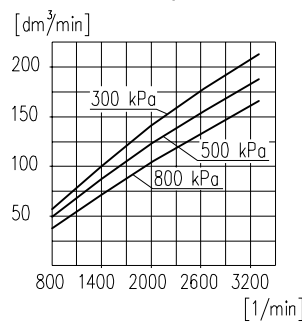

Power consumption

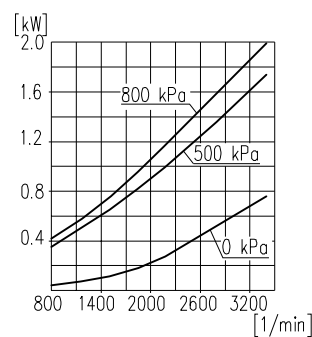

Time to fill a tank of 40dm<sup>3</sup> capacity

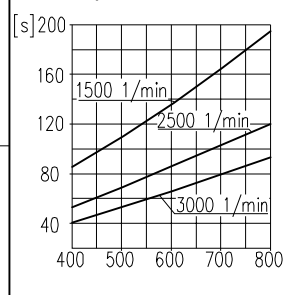

Max. r.p.m. for continuous duty

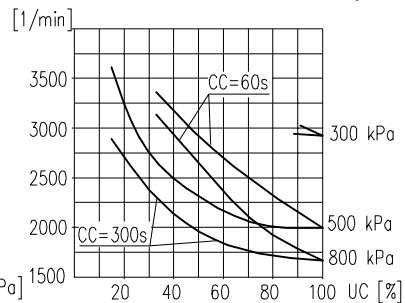

**TECHNICAL DATA:**

Number of cylinders 1  
 Cylinder diameter 60 mm  
 Piston stroke 36 mm  
 Total piston displacement 100 cm<sup>3</sup>  
 Mass 8,4 kg  
 Working pressure 800 kPa  
 Max. pressure for short time duty 1000 kPa  
 Max. allowable temp. of compressed air +220 °C  
 Cooling by inflation of, air with the speed of the stream min. 4 m/s  
 Lubrication forced circulation, splash lubrication  
 min. pressure of oil 300±200 kPa  
 (The pressure drop down is allowed to min. 60 kPa during the idle running of the heated up engine)  
 Normal speed max. 3000 1/min  
 Max. speed, temporary 3300 1/min

**SYMBOLS DESCRIPTION:**

0-suction connection  
 2-discharge connection  
 81-lubricating oil inlet  
 82-lubricating oil outlet and crankcase breathing

Digital marking according to International Standard ISO-6786

\*-max. angular tilt of the compressor

T-Datum plate

\*\* - Stopped by plug

**α, β, δ, γ** - max. angular deflection of the compressor

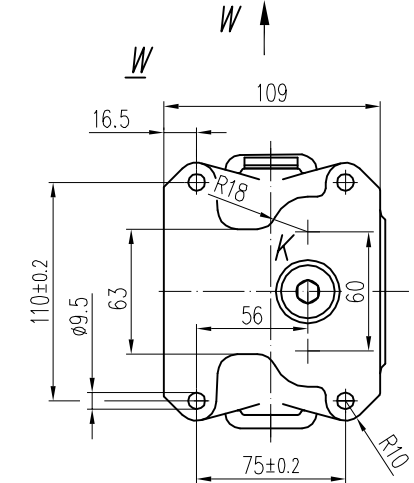
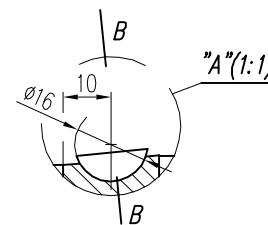
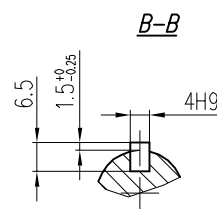
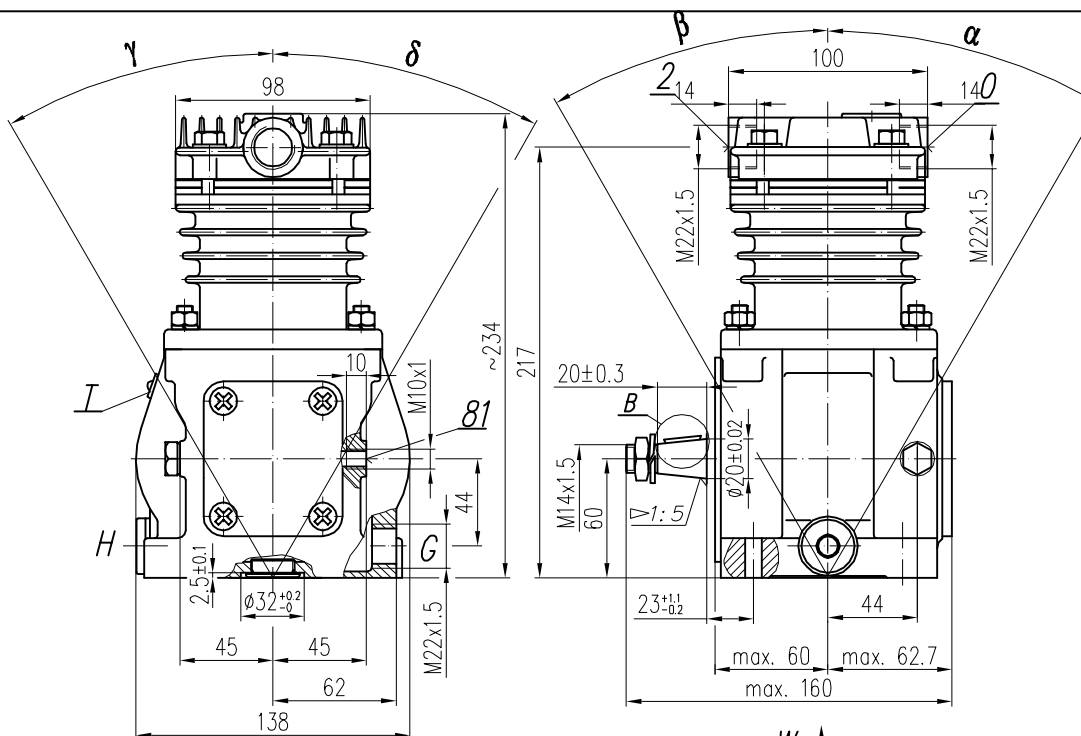

Compressor variants	
Scheme	Variant number
	601.35.931 601.35.941* 601.35.951**
	601.35.932 601.35.942* 601.35.952**
	601.35.933 601.35.943* 601.35.953**
	601.35.934 601.35.944* 601.35.954**

Variant nr without \* - 82 at the bottom, 81 position X  
 Variant nr with \* - 82 and 81 position X  
 Variant nr with \*\* - 82 and 81 position Y

	Description
	Discharge port
	Suction port

**NOTE!** The above characteristics are for open-inlet-valve control system at minimum cooling requirements and at ambient temperature +20°C

**DEFINITIONS:** CC=CT+CL - period of average operating cycle

$UC = \frac{CT}{CC} \times 100\%$  - percent ratio of compressor full load operating time in average operating cycle (also called percent duty cycle)

CL - compressor no-load operating time (exhaust to the atmosphere)

CT - compressor full load operating time

Port 82 position	α	β	γ	δ
G	20°	20°	15°	45°
H	20°	20°	45°	15°
K	20°	20°	30°	30°

GENERAL TOLERANCES				
CLASS	RANGE OF NOMINAL DIMENSIONS (±)MM			
	≤50	>50 ≤180	>180 ≤400	>400
II	1.0	2.0	3.0	4.0

FORCE, POWER PRESSURE ETC.	ANGLE
±10 %	±3°

OFFER DRAWING			
Konstr.	K.Malinowski	25.02.2010	FABRYKA OSPRZĘTU SAMOCHODOWEGO
Normaliz.	A.Walnicky		POLMO-Kódź S.A. FOS Stuzba Rozwoju
Sprawdzit	A.Walnicky		
Zatwierdzit	A.Walnicky		
Podziatka	Nazwa	1:2.5 Compressor 601.35.941	